



# **Beta**



## Power Pong **Beta** Table Tennis Robot User Manual

John Schmidt  
Revision 1.01

**Caution:**

- Please read this User Manual carefully before operating the Beta robot.
- Only utilize 110/220 VAC power based on the ordered product and configuration.
- The Ball Throwing Wheels rotate at high speed. Avoid touching during operation.

**IMPORTANT:** This User Manual has been developed exclusively for the Power Pong Beta table tennis robot. Copying this manual or any portion of it, without explicit permission in writing from Power Pong, is strictly prohibited.

# Table of Contents

<b>Section 1:</b>	<b><u><a href="#">Getting Started with the Beta Robot</a></u></b>	
1.1	Congratulations.....	1
1.2	Beta Table Tennis Robot Features .....	1
1.3	Included Parts .....	2
1.4	Terminology Used in this Manual .....	4
1.5	Power Pong Service / Support .....	4
<b>Section 2:</b>	<b><u><a href="#">Setup of the Beta Robot</a></u></b>	
2.1	Unfolding the Collection Net .....	5
2.2	Positioning the Support Legs .....	5
2.3	Rotating/Raising the Throwing Head into Play Position .....	5
2.4	Connecting the Throwing Head Communication Cable .....	8
2.5	Fully Opening the Collection Net .....	8
2.6	Mounting the Robot Base onto the Table .....	9
2.7	Adjusting the Support Legs (Rubber Tips) .....	9
2.8	Securing the Side Nets .....	10
2.9	Connecting the Control Panel Cable .....	10
2.10	Mounting the Control Panel to the Table.....	11
2.11	Connecting the Beta Robot to a Power Source .....	11
2.12	Load the Beta Robot with Table Tennis Balls .....	12
2.13	Congratulations – Setup is Complete .....	12
<b>Section 3:</b>	<b><u><a href="#">Beta Control Panel</a></u></b>	
3.1	Control Panel Description .....	13
3.2	Controls Affecting the Single Ball Type .....	13
3.2.1	Ball Placement Rotary Dials .....	13
3.2.2	Ball LEDs 1-6 .....	13
3.2.3	Trajectory Buttons / LED Display .....	14
3.2.4	Side-spin Buttons / LED Display .....	14
3.2.5	Spin Buttons / LED Display .....	15
3.2.6	Speed Buttons / LED Display .....	15
3.3	Controls Affecting All Thrown Balls .....	16
3.3.1	Ball/min Rotary Dial .....	16
3.3.2	AFC Button / LED .....	16
3.3.3	RND Button / rnd and Trnd LEDs .....	17
3.4	Memory Control Buttons / LEDs.....	18
3.4.1	Memory LED Display .....	18
3.4.2	Memory Location Increment Button .....	19
3.4.3	Memory Location Decrement Button .....	19
3.4.4	Clear Button .....	19
3.4.5	Save Button .....	19
3.5	Drill Controls .....	19

3.5.1	Add Ball Button .....	19
3.5.2	Remove Ball Button.....	20
3.5.3	Backstep Button .....	20
3.5.4	Sample Button.....	20
3.5.5	Start / Stop Button .....	20
3.5.6	Serve Button .....	20
3.5.7	Quit Buttons .....	21
3.6	Reset Buttons .....	21
<b>Section 4: <u>Operation of the Beta Robot</u></b>		
4.1	Tips for Best Operation and Longevity .....	22
4.2	Starting the Beta Robot .....	22
4.2.1	Checking Throwing Head Center Adjustment .....	22
4.3	Instant Play / Non-Memory Mode.....	23
4.3.1	Instant Play / Non-Memory Mode Practice Ideas with One Ball .....	23
4.4	Beta Robot Drills / Memory Mode .....	24
4.4.1	Pre-Configured Drills .....	24
4.4.2	Selecting / Starting a Drill .....	25
4.4.3	Creating a New Drill .....	25
4.4.4	Saving a Drill .....	26
4.4.5	Modifying an Existing Drill .....	26
4.4.6	Clearing/Removing a Drill from Memory.....	26
4.5	Using the Remote-Control FOB .....	27
4.6	Preparing for Transport and/or Storage .....	27
<b>Section 5: <u>Maintenance and Repair</u></b>		
5.1	General Cleaning of the Beta Robot .....	29
5.2	Deflector Assembly / Deflector Strip Cleaning and Replacement .....	29
5.2.1	Deflector Assembly / Deflector Strip Cleaning .....	29
5.2.2	Deflector Strip Service/Replacement.....	30
5.3	Throwing Wheel Maintenance .....	32
5.3.1	Checking Wheel Clearance .....	32
5.3.2	Adjusting Wheel Clearance .....	32
5.3.3	Lower Wheel Removal / Replacement .....	33
5.3.4	Upper Wheel Removal / Replacement .....	34
5.4	Robot Base Assembly / Lower Ball Feed Path Cleaning .....	35
5.5	Calibration .....	36
5.5.1	Checking Calibration .....	36
5.5.2	Performing Calibration .....	37
5.6	Replacing the Battery in Remote-Control FOB .....	37
5.7	Replacing the Main Circuit Board .....	39
5.8	Pairing a New Remote-Control FOB .....	40
5.9	Restoring Factory Supplied Drills .....	41
5.10	Typical Replacement Parts .....	41

**Section 6: [Troubleshooting](#)**

6.1	Ball Jams .....	42
6.2	General Troubleshooting .....	43
	Technical Data / Warranty Information .....	44

## Section 1: Getting Started with the Beta Robot

[Back to Table Of Contents](#)

### 1.1 Congratulations

Congratulations on your purchase of the Power Pong Beta Table Tennis robot, the “best in its class”, outstanding product, and top performing robot. The Beta robot is ideal for every type of player and every level of play. With proper care and treatment this robot will give you years of quality practice time!



### 1.2 Beta Table Tennis Robot Features

Below are some of the features of the Power Pong Beta robot:

- Compact, solid, functional constructed robot with integrated ball collection net – allows continuous practice without having to stop to collect balls
- Lightweight and easily transportable. The robot with included accessories weighs less than 20 lbs.
- State-of-the-art 3-wheel ball delivery technology utilizing rigid sponge wheels designed for long durability
- User-friendly, easy to understand Control Panel
- Ball delivery options include a variety of spin types, trajectory, and placement – all adjustable through the Control Panel
- Random features include natural scattering of shots with random placement and random sequencing of Drills
- Comes with 31 pre-configured drills with different spin, speed, trajectory, and placement
- Additional 19 memory locations for your own customized drills
- Configurable option for more natural timing of thrown balls during drills
- Adjustable height of ball delivery to simulate anything from low serves to high lobs
- Remote-Control FOB included allows starting/stopping and changing the throwing rate.

**The Power Pong Beta tennis table robot is covered by a full 3-year Manufacturer’s warranty and a 5-year guarantee of parts and service availability. See full warranty information at the end of this User Manual.**

### 1.3 Included Parts

<p>Robot with Net Assembly</p>	
<p>Power Supply (Input: 100-240V, Output: 24V DC, 3A) with cable</p>	
<p>Control Panel</p>	

<p>Control Panel Cable</p>	
<p>Control Panel Mounting Bracket</p>	
<p>100 Power Pong Table Tennis balls</p>	
<p>Remote-Control FOB</p>	
<p>Adjustment Gauge/Tool</p>	



#### Other miscellaneous parts:

2mm and 4mm Hex wrenches

Velcro strips

Flexible white replacement deflector strip

Non-Flexible, rigid white replacement deflector strip

Spare rubber bands (2)

## **1.4 Terminology Used in this Manual**

Following is a list of terms that are used throughout this User Manual along with brief definitions.

**Ball Throw** – the action of the Beta robot throwing a ball to a location on the table

**Ball Throw Type** - 4 controls affect Ball Type: Top Spin/Back Spin, Speed, Sidespin, and Trajectory

**Bal Feed Tube** – the path the balls follow from the base of the robot up to the throwing head.

**Basic Ball** - the ball that is thrown when the Control Panel is first powered on and no adjustments have been made. This ball will have no spin with medium speed and height.

**Current Ball** - the ball that is currently selected as indicated by its flashing Ball LED.

**Drill** - a configurable sequence of between 2 and 6 ball throws that upon starting, repeats until stopped

**Elevation Rings** — Rings painted onto the Ball Feed Tube, which are used to adjust the ball throwing height.

**Existing Drill** – a Drill that is currently stored in a Memory Location of the Beta robot

**Placement** - the location on the table where a ball lands, determined by the rotary placement dial

**Rotary Dial** – a dial that can be rotated to change operation of the robot

**Short Button Press** – a short button press is approximately 1 second or less

**Long Button Press** – a long press is approximately 2 seconds or more

**Throwing Head Assembly** – the portion of the robot that contains the 3 motors/wheels for throwing the balls

## **1.5 Power Pong Service / Support**

For assistance or service of your Power Pong Beta Table Tennis robot, please email Power Pong support at [support@powerpong.org](mailto:support@powerpong.org)

Please provide the following information:

1. Your full name.
2. Your phone number
3. The Model of your table tennis robot (i.e. Alpha, Beta, Delta, Omega)
4. A full description of the issue you're having with the robot.

You may also call Power Pong Support at: 714-280-6821.

We look forward to helping you! A Power Pong service representative will respond to you promptly.

## Section 2: Setup of the Beta Robot

[Back to Table Of Contents](#)

### 2.1 Unfolding the Collection Net

1. Place the robot on top of your table tennis table. (Photo 2-1)
2. Fold apart both sides of the net at the same time until the first stop. The net bars will be horizontal at this point as shown. (Photo 2-2)

Photo 2-1



Photo 2-2

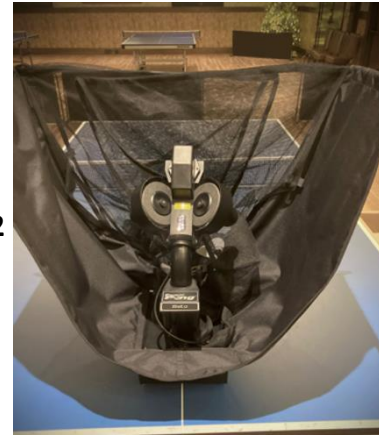

### 2.2 Positioning the Support Legs

1. Swing the curved tubular Support Legs **outward** toward the front of the robot into position (Photo 2-3), approximately 6-8 inches apart.

Photo 2-3

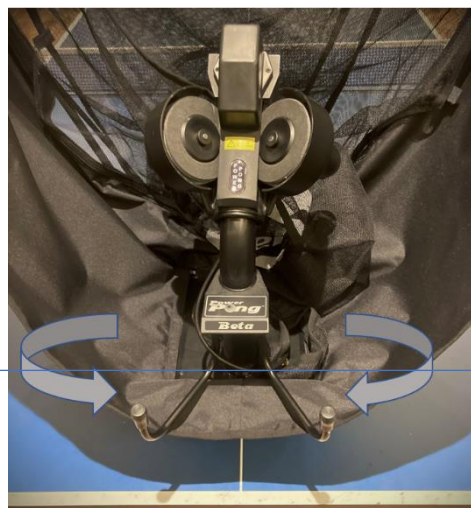

### 2.3 Rotating/Raising the Throwing Head into Play Position

The flexibility of being able to adjust the throwing height of the Beta robot allows for a very realistic match experience. By adjusting the height (from one of four different positions) together with the ball trajectory settings, you can have the robot throw you any type of ball from a low fast serve to a high lob.

**Note:** If you are unpacking the unit for the first time, remove the rubber bands used on the throwing head which protect the Deflector Plates during shipment.

When adjusting throwing head height, always be sure that one of the 4 painted rings is slightly above the Ball Feed Tube Locking Assembly. Failure to adjust the height properly can lead to throwing malfunctions, including throwing two balls simultaneously.

1. Loosen the Throwing Height Adjustment Knob found on the rear of the Ball Feed Tube Locking Assembly typically one-half to one turn. (Photo 2-4)

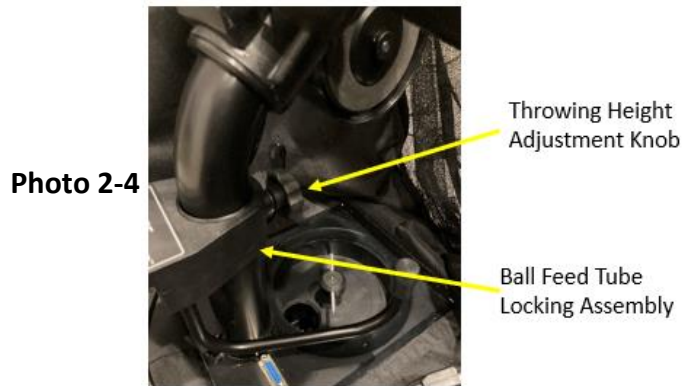

2. Grasp the curved Ball Feed Tube and rotate approximately 180° so that the ball head / exit route is pointing toward you and/or the front of the robot. You may have to pull the Ball Feed Tube slightly upwards to rotate. See Photo 2-5 (before) and Photo 2-6 (after).



3. Pull the head upwards on the Ball Feed Tube until the second ring on the tube is just visible (Photo 2-7). **SLIGHTLY** tighten the Throwing Height Adjustment Knob to hold the throwing head in place - just enough to prevent it from dropping.

**Caution:** Overtightening can damage the Ball Tube!

Photo 2-7



Second Ring just Visible

The height of the throwing head can be adjusted to one of four possible heights as shown in photos 2-8 thru 2-11. Before tightening the Throwing Height Adjustment Knob, it is important that one of the Ball Feed Tube rings be located just above the Ball Feed Tube Locking Assembly.

**Never operate the robot with the height beyond the 4<sup>th</sup> red ring.**

Photo 2-8



1 Ring Exposed  
(Minimum Height)

Photo 2-9



Photo 2-10



3 Rings Exposed

Photo 2-11



4 Rings Exposed  
(Maximum Height)

## 2.4 Connecting the Throwing Head Communication Cable

1. Connect the Communication Cable coming from the Throwing Head Assembly to the 15-pin connector found on top of the robot base (Photos 2-12, 2-13 and 2-14).

Photo 2-12



Photo 2-13



Photo 2-14



2. Tighten (snug) the two thumb screws on the cable connector. **Note:** This cable **MUST** be disconnected anytime you swing the table support legs back into their transport position to prevent damage to the cable.

## 2.5 Fully Opening the Collection Net

1. Standing behind the robot, grip the top points of the net and completely fold the net down on both sides until the net fully opens (Photo 2-15).

Photo 2-15



## 2.6 Mounting the Robot Base onto the Table

1. From behind, grasp the robot with both hands on the bottom of the base. Pick up the robot, angle the Support Legs downward, and slip them under the end of your table. (Photo 2-16)
2. Gently push the robot onto the end of the table with the Power Pong logo aligned with the center line of the table. (Photo 2-17)
3. Carefully let go of the robot base and it will hang securely by its own weight.
4. Lower the Corner Brackets of the net around the corners of your table.
5. With a newer robot, the corners of the net may not stay completely down at this point – this is okay and as the material loosens up the corners will stay in place.

**Note:** If the table to which you are attaching the robot to, is the table that you will always use, you can secure the mounting by using the included longest Velcro strip to secure the robot to the end of the table. You may also use supplied Velcro on the corners of the table.

Photo 2-16



Photo 2-17



## 2.7 Adjusting the Support Legs (Rubber Tips)

The Beta robot is designed with adjustable Support Legs allowing it to fit onto tables with a variety of thicknesses, up to 1 inch. There are adjustable rubber tips on the end of the Support Legs that can be turned clockwise or counterclockwise, as needed for your table, **so that the Throwing Head Assembly is positioned straight up and NOT tilting either forward or backward**. Failure to adjust the legs properly will cause ball placement to be inaccurate.

1. Turn the **adjustable rubber tips** on the ends of the Support Legs as needed so that the Ball Feed Tube is straight up, not tilting forward/backward. (Photo 2-18, Figures 2-1, 2-2)

Photo 2-18

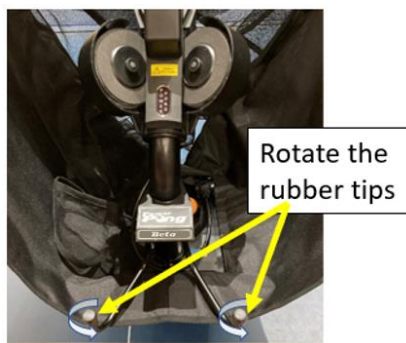
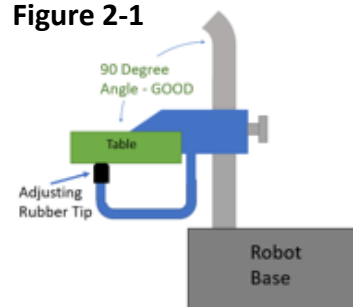
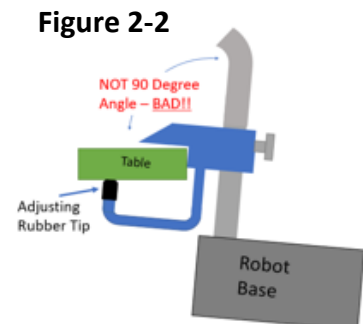

Figure 2-1



**CORRECTLY** Adjusted Rubber Tips

Figure 2-2



**INCORRECTLY** Adjusted Rubber Tips

## 2.8 Securing the Side Nets

1. Pull one of the Side Nets along the side of the table and secure to the net post hardware (Photos 2-19 and 2-20), by looping the rubber band **over the top** of the net support and then down around the clamp screw that holds the net support onto the table.
2. Repeat with the other Side Net.

Photo 2-19



Photo 2-20

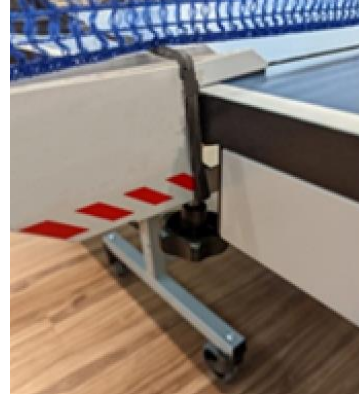

## 2.9 Connecting the Control Panel Cable

1. Connect either end of the Control Panel Cable into the jack (looks like a headphone jack) on the side of the Robot Base Assembly (Photo 2-21). Be sure to fully seat/insert this cable.

Control Panel  
Cable/Connector

Photo 2-21

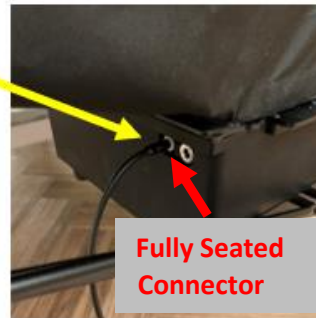

2. Extend the other end of the Control Panel Cable to the opposite side of the table and connect to the Control Panel (see Photo 2-22 and 2-23). Be sure to fully seat/insert this cable.



Photo 2-22

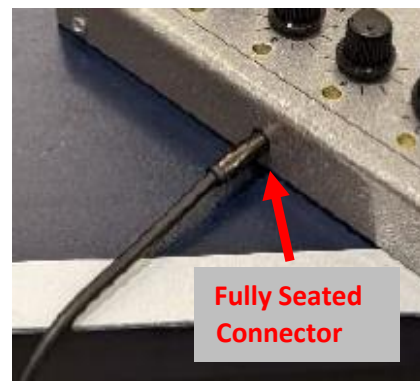

Photo 2-23

## 2.10 Mounting the Control Panel to the Table

The Control Panel Bracket and Control Panel can be mounted on either side of the table.

1. Attach the Control Panel Bracket onto the side of the table, near the end so that you can easily reach/operate it. (Photo 2-24)



Photo 2-24

2. Attach the Control Panel to the mounting tabs on the Control Panel Bracket. You may use a Velcro strip to help secure the bracket onto the side of the table if you will always be using the same table. (Photo 2-25)



Photo 2-25

## 2.11 Connecting the Beta Robot to a Power Source

1. Insert the power connector from the power adapter into the power jack on the side of the Robot Base Assembly. (Photo 2-26)



Photo 2-26



2. Plug the power adapter into the wall power (110VAC) as shown in Photo 2-27. When you do this, you will hear the Beta robot begin its startup process consisting of several clicking noises followed by the ball throw motors spinning for 1-2 seconds.

Photo 2-27



## 2.12 Load the Beta Robot with Table Tennis Balls

1. Using the supplied table tennis balls, fill the collection net assembly (Photo 2-28).

Photo 2-28



## 2.13 Congratulations – Setup is Complete

Setup of your Beta robot is complete, and the unit is ready for use!

## Section 3: Beta Control Panel

[Back to Table Of Contents](#)

### 3.1 Control Panel Description

The Beta control panel is used to control all aspects of how the balls are thrown/delivered to you. This includes the placement of the ball on the table, as well as speed, spin and more. Through the control panel, you also start and stop the process of balls being thrown and, you control the rate at which they are thrown. Drills, which will be covered in Section 4, are created, modified, and saved using the control panel. In this section of the User Manual, we cover the function of the individual buttons, dials, and LEDs that are part of the control panel.



Photo 3-1

### 3.2 Controls Affecting the Single Ball Type

#### 3.2.1 Ball Placement Rotary Dials (Figure 3-1)

There are six Placement Rotary Dials, with LEDs above each dial. These dials (1-6) determine the left to right landing spot of the ball, related to the centerline of the table. When the indicator dot on the dial is centered, the ball will be delivered approximately down the center line of the table. As the dial is turned to the left (of center), the ball will be delivered to the left of the center line on the table. As the dial is turned to the right (of center) the ball will be delivered to the right of the center line on the table. The farther the dial is turned from center, the farther the ball will be from the centerline, either left or right.

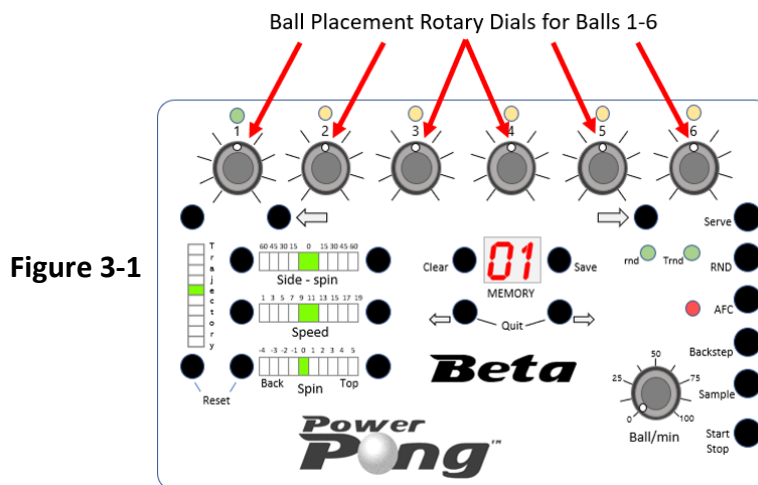

Figure 3-1

#### 3.2.2 Ball LEDs 1-6 (Figure 3-2)

Above each Ball Placement Rotary dial is an LED. When the LED is flashing, the corresponding Ball Placement Rotary Dial is active, and when the dial is turned, the deflector plates on the throwing head will move. The number below the flashing LED will be referred to as the “active ball”. Additional controls, such as speed, spin, trajectory, etc. can be adjusted to affect the active ball. When illuminated and solid, this indicates that a Ball for that number has been

programmed. The total number of illuminated LEDs will indicate the total number of balls that have been programmed.

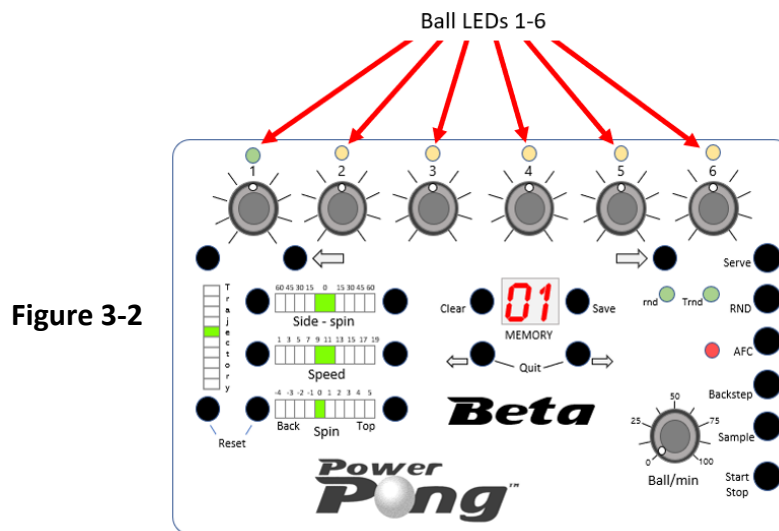

Figure 3-2

### 3.2.3 Trajectory Buttons / LED Display (Figure 3-3)

The Trajectory Buttons raise or lower the active ball trajectory (throw angle). One short press of either button will change the trajectory by about one-half degree, either up or down. If you hold either button down (long press), the change in trajectory can be made rapidly. The Trajectory LED display will update with major changes (8 or more short presses) of the trajectory button.

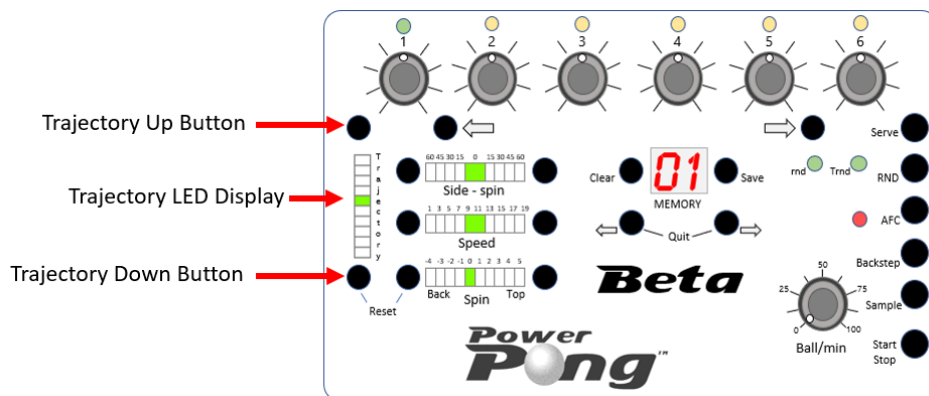

Figure 3-3

### 3.2.4 Side-spin Buttons / LED Display (Figure 3-4)

The Side-spin buttons change the type and amount of side spin on the active ball. When the zero LED is illuminated, that means there is no side spin on the active ball. Using the buttons, we can change the amount of spin and whether the spin is left or right. The Side-spin LED will update with each click (left or right) and will apply to the active ball.

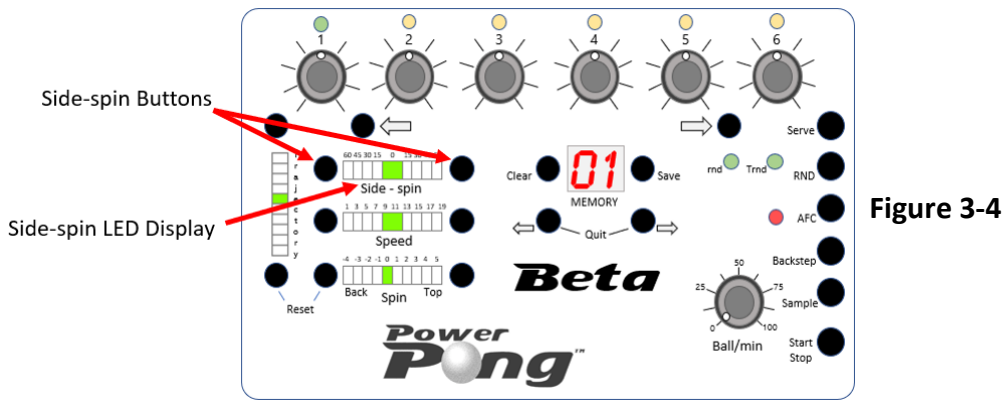

Figure 3-4

### 3.2.5 Spin Buttons / LED Display (Figure 3-5)

The Spin buttons reduce or increase the amount of spin on the active ball – either Top-spin or Back-spin. A setting of zero indicates no spin (dead ball). Settings to the right of zero (1 to 5) indicate stronger and stronger amounts of Top-spin. Settings to the left of zero (-1 to -4) indicate stronger and stronger amounts of Back-spin. The Spin LED will update with each click (left or right) and will apply to the active ball.

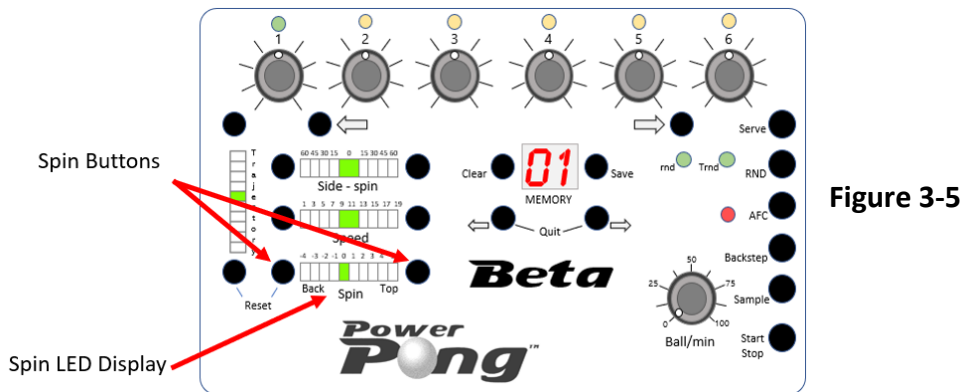

Figure 3-5

### 3.2.6 Speed Buttons / LED Display (Figure 3-6)

The Speed buttons reduce or increase the speed of the ball. There are 19 increments of speed adjustment. The Speed LED will update with each click (left or right) and will apply to the active ball.

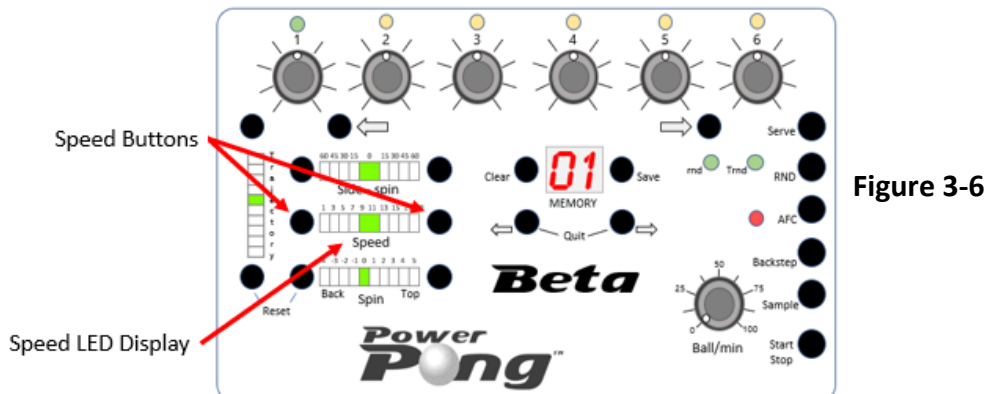
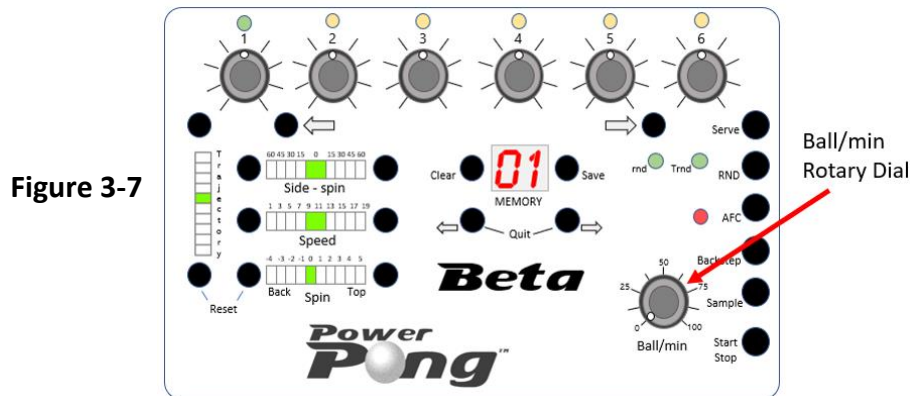

Figure 3-6

### 3.3 Controls Affecting All Thrown Balls

#### 3.3.1 Ball/min Rotary Dial (Figure 3-7)

The Ball/min rotary dial decreases or increases the rate, or frequency of thrown balls per minute. This control affects all balls thrown, not just the active ball. An adjustment of 0 to 100 balls per minute is possible. Turning the Ball/min rotary dial to the “0” position will stop the feeding motor as well as the three throwing motors.



#### 3.3.2 AFC Button / LED (Figure 3-8)

By pressing the AFC button, you activate the Automatic Frequency Control function. The red AFC LED will illuminate on the control panel. AFC is useful when you have a sequence of balls with significant changes in speed from one ball to the next. An example would be, when you start with a slow, short backspin serve followed by a fast topspin shot. Or you have several fast top-spins followed by a slow, high pop-up lob. AFC can sense this change in speeds and automatically adjust the ball frequency so the timing between shots is more like the timing of shots in a real game. Turn on AFC whenever you feel you don't have enough time, or too much time, for one or two balls within a drill, but the rest of the balls seem okay. Deactivate AFC by once again pressing the AFC button again. The AFC LED will turn off.

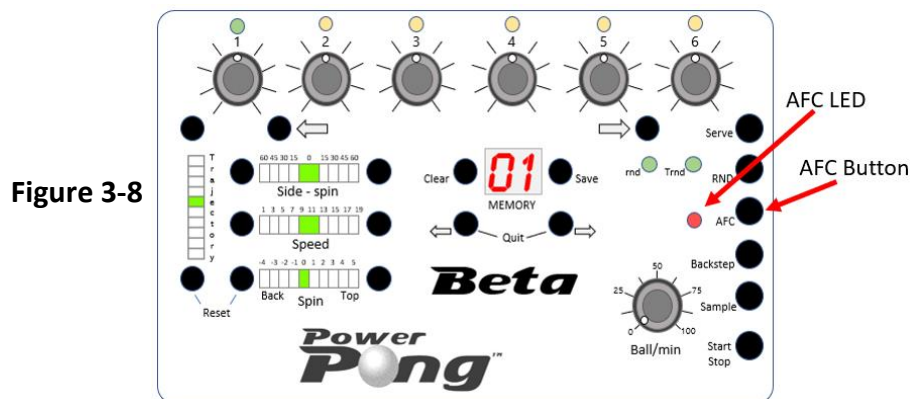

### 3.3.3 RND Button / rnd LED and Trnd LEDs (Figure 3-9)

The Power Pong Beta robot provides the option for three types of randomizations (Random Sequence, Random Placement, Random Sequence + Random Placement) to make your practice sessions more realistic. The random functions are activated with the RND button.

**Random Sequence mode** - Pressing the RND button the first time will select Random Sequence and the Trnd LED will illuminate. In Random Sequence mode, the robot will randomly select one of the balls in the current drill/sequence and throw it, then randomly select another ball in the drill and throw it, etc. RATHER than just throwing in normal sequence. This feature creates many different variations within a 6-ball drill. Random Sequence requires at least two Balls to be active and/or in a drill. If there is only a single Ball active and/or in a drill, Random Sequence cannot be activated and the Trnd LED will not light.

**Random Placement mode** - Pressing the RND button a second time will select Random Placement, will illuminate the rnd LED and will turn off the Trnd LED. Random Placement mode is similar to the less precise shots that a human might deliver. With Random Placement, balls are delivered within an area of approximately 16 inches in diameter, relative to or around the originally set placement/location.

Pressing the RND button a third time will enable both Random Sequence and Random Placement, simultaneously. The Trnd and rnd LEDs will both illuminate. This option will give you the greatest randomness during your practice sessions.

Pressing the RND button a fourth time will turn both Random Sequence mode and Random Placement mode off (and both Trnd and rnd LEDs will turn off).

**Note:** When using the Random Placement mode, do not choose ball placements that are close to the side of the table, end line of the table, or near the table net. If you do, some balls are likely to be placed over the side, over the end of the table or into the net because of the increased area/randomness of the placement for the balls.

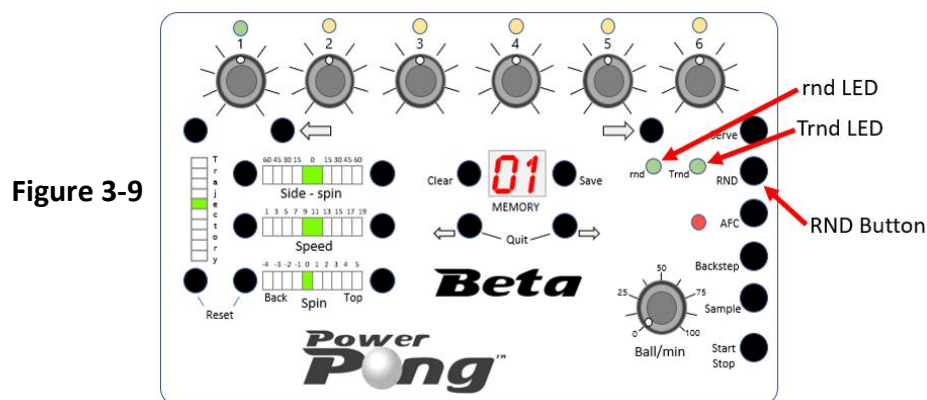

### 3.4 Memory Control Buttons / LEDs

The Beta robot has 50 Memory Locations which can store drills/sequences of two to six different ball types and placements. 31 of the Memory Locations (20-50) come with pre-loaded drills for your practicing experience. In this section, the controls related to Memory Locations and Drills are explained. The actual usage of Drills is covered in Section 4.

#### 3.4.1 Memory LED Display (Figures 3-10 and 3-11)

The Memory LED Display indicates whether the robot is in Non-Memory/Instant Play mode (a "1" on the display) or that the robot is in Memory Mode and which Memory Location is active. Memory Locations are indicated with a number ranging from "01" to "50". If the Memory LED Display is flashing a number, this indicates that the Memory Location is unused and is not holding a drill.

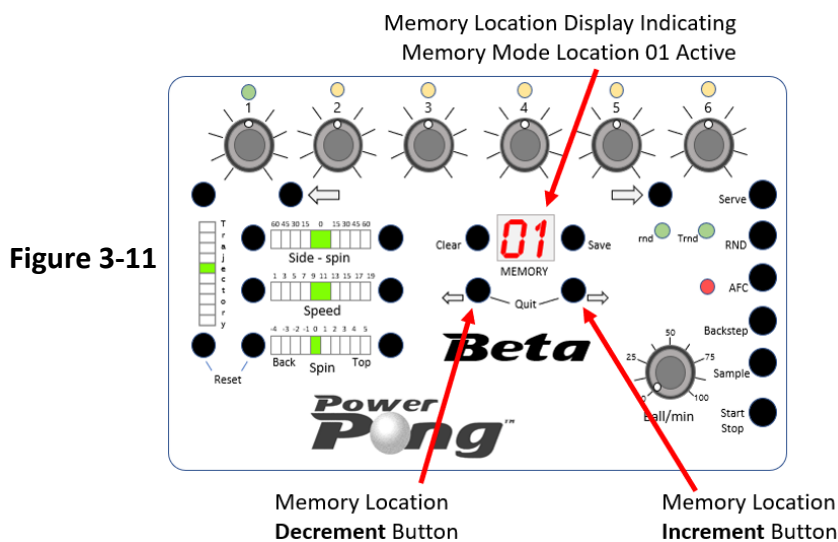
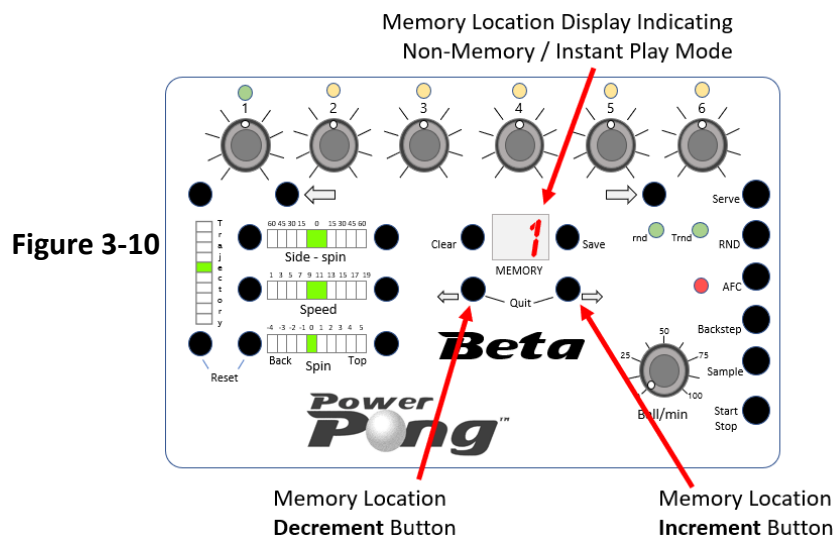

### 3.4.2 Memory Location Increment Button (Figure 3-11)

Pushing the Memory Location Increment button once will **increment** the active Memory Location by 1. Holding the button down will **increment** the Memory Location at a faster rate. Pushing this button while the number 50 is displayed will cause the controller to loop forward to Memory Location 01.

### 3.4.3 Memory Location Decrement Button (Figure 3-11)

Pushing the Memory Location Decrement button once will **decrement** the active Memory Location by 1. Holding the button down will decrement the Memory Location at a faster rate. Pushing this button while the number 1 is displayed will cause the controller to loop back to Memory Location 50.

### 3.4.4 Clear Button (Figure 3-12)

Pushing and holding the Clear button for 2 seconds will erase/clear the contents of the Memory Location for the position identified by the Memory LED Display. The ball attributes such as Spin, Speed, Side-spin, etc. will all be reset to their default settings. A flashing Memory LED Display verifies that the Memory Location has been cleared successfully.

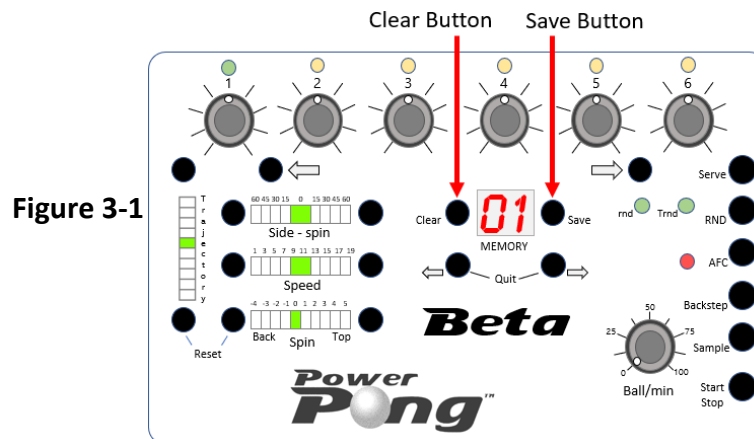

Figure 3-1

### 3.4.5 Save Button (Figure 3-12)

Pushing and holding the Save button until it becomes blank will save the current drill based on the number of active balls and the settings for each active ball. Upon releasing the button, the Memory Location will again be displayed. The Save button is not active in Non-Memory / Instant Play mode.

**Note:** Saving a drill will erase any drill that was previously stored in the indicated Memory Location.

## 3.5 Drill Controls

### 3.5.1 Add Ball Button (Figure 3-13)

Pushing the Add Ball button will add a ball to the current drill (up to six balls). The new ball will automatically include the settings copied from the previous ball, which can be modified.



### 3.5.2 Remove Ball Button (Figure 3-13)

Pushing the Remove Ball button will remove the last ball in the current sequence/drill.

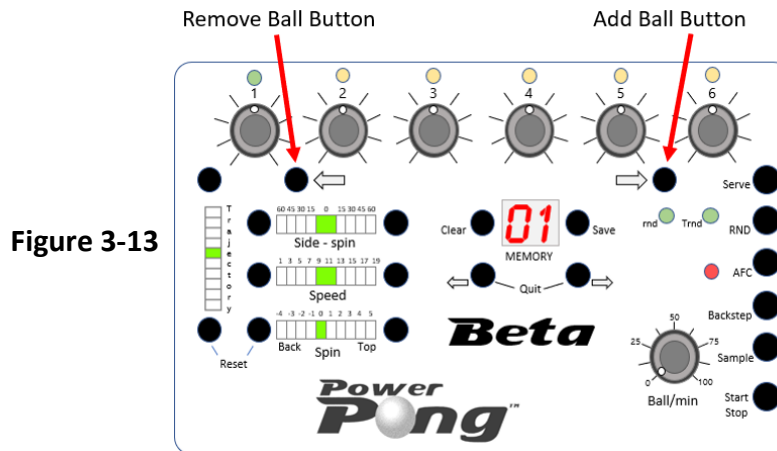

Figure 3-13

### 3.5.3 Backstep Button (Figure 3-14)

The Backstep button allows you to step (in reverse order), through the balls in the current drill allowing you to stop at any ball to modify one or more settings. Each press of the Backstep button will change the active Ball, which is indicated by the LED above the Ball Placement Rotary Dial. To save any changes, you must press of the Save button as previously described.

### 3.5.4 Sample Button (Figure 3-14)

Pushing the sample button will cause the active ball to be delivered continuously until the button is pushed again. The balls are delivered at a rate between 55 and 60 balls per minute.

### 3.5.5 Start / Stop Button (Figure 3-14)

Press the Start / Stop button briefly to start or stop (toggles) ball delivery.

### 3.5.6 Serve Button (Figure 3-14)

Pushing the Serve button will generate a slight delay before each iteration of a drill. The amount of delay will change with the Ball/min setting. Faster Ball/min settings will result in shorter delay times.

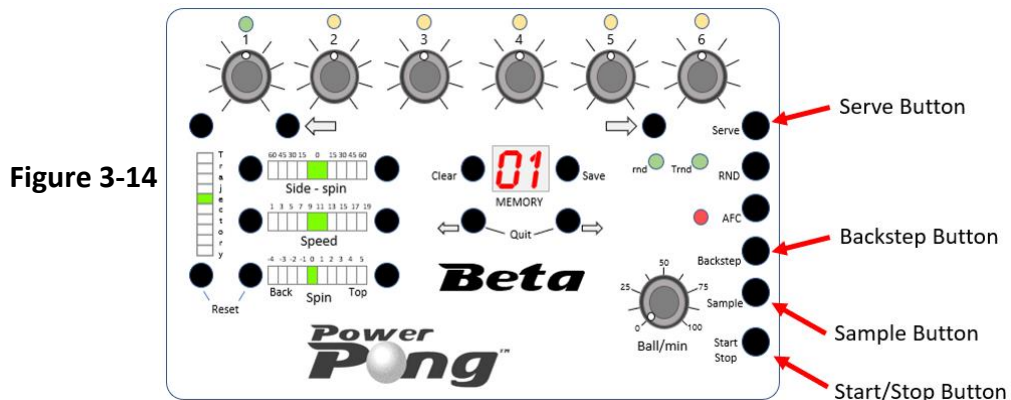
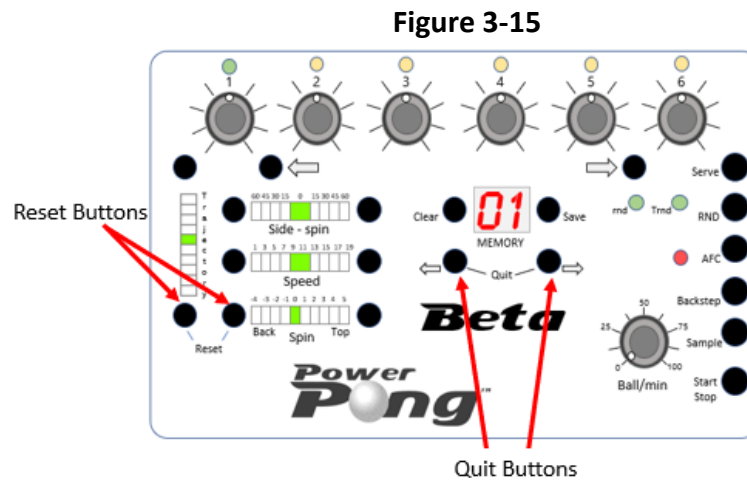

Figure 3-14

### 3.5.7 Quit Buttons (Figure 3-15)

The Quit Buttons when held down together for approximately 2 seconds will put the control panel back into Non-Memory/Instant Play mode.



### 3.6 Reset Buttons (Figure 3-15)

The Reset buttons when held down together for approximately 3-5 seconds will reinitialize the throwing head of the robot.

## Section 4: Operation of the Beta Robot

[Back to Table Of Contents](#)

### 4.1 Tips for Best Operation and Longevity

For best operation and longevity, follow the guidelines below.

- The Beta robot works best when using the supplied Power Pong table tennis balls. Other brands may be used but the size must be comparable with the Power Pong supplied balls.
- New balls should be washed and dried, to remove residual manufacturing dust before being used in the Beta robot.
- Keep all balls, new or old, that you use in the robot clean. When the balls contact the floor in your playing area, they may pick up dirt and various debris. This dirt/debris can be transferred into the robot, onto the robot ball throwing wheels, reducing the performance of the robot. See Section 5 (Maintenance) for instructions on cleaning the Beta robot.
- The Beta robot is designed for use in dry, indoor rooms. Do not use outdoors or in any wet or damp environment.
- Avoid leaving your robot where it is exposed to heat such as a hot car or trunk.
- Do not allow objects including dented balls, hair, string, etc. to fall into the collection net where they can work their way into the robot. These objects can cause ball jams, interfere with correct operation and/or damage the robot.

### 4.2 Starting the Beta Robot

1. Setup the Beta robot as covered in Section 2, including placing at least 50 table tennis balls into the net trays. For best results, use the supplied balls from Power Pong.
2. If not already done, plug the Beta robot power adapter into a power outlet. After a brief startup/initialization sound, the Ball 1 LED on the Control Panel should be flashing.
3. Place the Rotary Placement dial for Ball 1 in the center position.
4. Place the Rotary dial for Ball/min to 25.
5. Press the Start button on the Remote-Control FOB, or the Start/Stop button on the Control Panel (to start). You will hear the wheels start spinning and balls will begin loading into the machine and travelling up the ball throwing assembly. After a few seconds, the first ball will reach the top of the Ball Feed Tube and will be delivered. Balls will continue to be delivered until you press the Start/Stop button again or press the Stop button on the Remote-Control FOB.

#### 4.2.1 Checking Throwing Head Center Adjustment

The first balls that are thrown will be Basic Balls and should be delivered along the centerline. This is based on having the Rotary Placement dial for Ball 1, directly in the center. Observe where the balls land in relation to the centerline. If balls are delivered either left or right of the centerline, perform the following:

1. Stop ball delivery by pressing the Start/Stop button on the Control Panel.

2. At the robot, loosen the Ball Height Adjustment Knob on the rear of the Ball Feed Tube Locking Assembly.
3. Carefully rotate the head as needed for balls to land closer to the centerline.
4. Restart the ball delivery by pressing the Start/Stop button on the Control Panel and repeat this process until all balls are landing as close to the centerline as possible.

### 4.3 Instant Play / Non-Memory Mode

Immediately upon power up of the Beta robot, it will display a “1” for the Memory Location. This is different than “01”. The “1” means that the robot is in Non-Memory mode. You can use all of the robot features; however, you won’t be able to save to memory. This is typically used for Instant Play when you just want to start practicing without regard for any drill.

Perform the following steps:

1. Set of the Ball/min rotary dial to a value greater than 0
2. Push the Start/Stop button on the Control Panel or the Start button on the Remote-Control FOB. The robot will begin throwing balls to you based on the ball placement and settings for Ball 1. You may adjust the placement, as well as all other controls at this point to achieve the desired spin, speed, etc.
3. Push the Start/Stop button on the Control Panel to stop the robot.

#### 4.3.1 Instant Play / Non-Memory Mode Practice Ideas with One Ball

Below are a few examples of exercises you can do just using Ball 1 setup.

**Forehand Practice** - If you want to practice forehand returns, turn the Ball 1 Placement dial to the right of Center. Press the Start/Stop button to begin. The robot will repeatedly throw forehand balls.

**Backhand Practice** - If you want to practice backhand returns, turn the Ball 1 Placement dial to the Left of Center. Press the Start/Stop button to begin. The robot will repeatedly throw backhand balls.

**Alternating Forehand/Backhand Practice Emphasizing Footwork** - Set the Ball 1 Placement in the center. Press the Start/Stop button to begin. Use footwork to alternatively position yourself for forehand, then backhand, without the ball placement itself changing.

Keep in mind that during these Instant Play Mode practice exercises, you can always adjust the following controls from the Control Panel:

- Ball Speed
- Ball Trajectory
- Side Spin
- Top/Bottom Spin
- Balls / Minute
- Ball Placement (Random Placement mode can also be turned on)

**Note:** You can also adjust the height of the Throwing Head assembly to one of four possible heights to vary the balls that are thrown to you!

## 4.4 Beta Robot Drills / Memory Mode

Drills are sequences of two to six balls, thrown to different locations (if desired), with different spins and speed (as desired), that will be repeated, allowing you to create an endless number of training exercises. Once a drill is designed and setup, it can be saved to a Memory Location of the Beta robot for future use. The robot must be in Memory Mode. If there is a “1” on the Memory Location LED press the Memory Increment button to activate Memory Mode. The display will indicate “01” (or any other numeric value other than “1”).

### 4.4.1 Pre-Configured Drills (Table 4-1)

The Beta robot comes with 30 pre-configured drills in Memory Locations 21 through 50, that can be easily accessed and used for training. The drills are designed to be used with the throwing head at the 2<sup>nd</sup> ring/height however individual adjust may be utilized. Following is a listing/description of the drills.

**Table 4-1**

Memory Location	Description
20	Light topspin to backhand
21	Light topspin to forehand
22	Light topspin 1 to forehand and 1 to backhand
23	Light backspin to backhand (more backspin than 20-22)
24	Light backspin to forehand
25	Light backspin 1 to backhand & 1 to forehand
26	Light backspin to backhand & Light topspin to backhand.
27	Light backspin to forehand & Light topspin to forehand.
28	Serve to forehand and light topspin to backhand.
29	Serve to backhand and light topspin to forehand.
30	Topspin to forehand and topspin to backhand.
31	2 topspin to backhand and 1 to forehand.
32	2 topspin to backhand and 2 to forehand.
33	Topspin to backhand, middle, backhand, forehand.
34	Heavier topspin to backhand.
35	Backhand, middle, forehand.
36	Light backspin to backhand, middle, forehand.
37	One light & one heavier under spin to forehand.
38	Heavier topspin to forehand & backhand.
39	Lob to forehand.
40	Lob to forehand & backhand.
41	Under spin lob to backhand
42	Under spin serve backhand.
43	Side spin serve to forehand.
44	Side spin serve to backhand
45	Serve to middle.
46	Serve to backhand, lob one to forehand and one to middle.
47	No spin serve to forehand, topspin one to backhand, one to forehand, drop shot.
48	Backspin serve to backhand, topspin to forehand, middle and backhand

49	Side spin serve to backhand, 2 topspin to forehand, 1 to middle
50	Side spin – 1 to forehand, 3 to backhand, 1 to forehand

#### 4.4.2 Selecting / Starting a Drill (Figure 4-1)

1. Select the desired Drill number with the Memory Location Increment/Decrement buttons. The Drill automatically becomes active. The number of balls in the drill will be indicated by the number of LEDs illuminated above the Ball Placement Rotary dials.
2. Set the Ball/min rotary dial to a value greater than 0.
3. Press the Start/Stop button to start the selected drill. The robot will start throwing/cycling through the balls that are in the drill until you push the Start/Stop button again to stop.

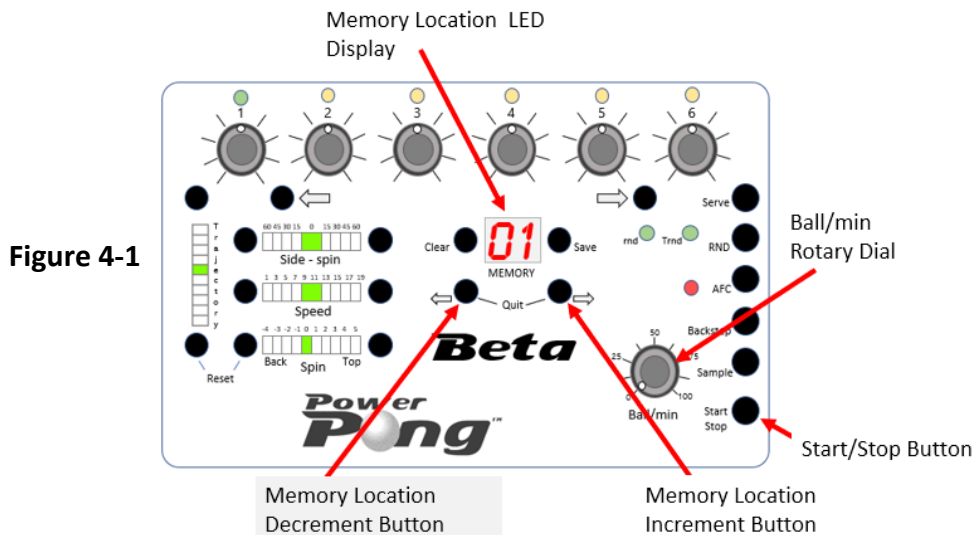

**Note:** It is important to understand that Ball Placement is stored as part of every ball in a saved Drill. This means that when you select a drill, depending on the position of the Ball Placement Rotary Dials when the drill is selected, the actual ball placement on the table may or may not correspond. If you adjust a Ball Placement Rotary Dial for an active ball, the placement will re-sync with the dial once again.

#### 4.4.3 Creating a New Drill

Before programming the Beta robot with a new drill, you may find it useful to design your drill ahead of time, on paper or in your head. Think about the number of balls that you want in your drill as well as the ball attributes including ball placement, ball speed, ball height, spin, etc., for each ball. When you are ready to enter the drill, perform the following steps.

1. If the robot is throwing balls, push the Start/Stop button to stop.
2. Make Ball 1 the Active Ball (if it's not already) which will be indicated by the flashing LED above the Ball 1 Rotary dial. If the LED above the Ball 1 rotary dial is not flashing, push the Backstep button as many times as necessary to accomplish this. (You can also use the Remove Ball button)
3. Set the specific ball attributes (Spin, Speed, Trajectory, and placement) for Ball 1.

4. Push and hold the Sample button to test your Ball 1 setup. Make any adjustments to Ball 1 as needed.
5. Push the Add Ball button which will add Ball 2 to your drill. It will also copy the Ball 1 settings to Ball 2 (except for placement).
6. Set the specific ball attributes that you want for Ball 2 (Spin, Speed, Trajectory, and placement).
7. Push and hold the Sample button to test your Ball 2 setup.

Continue this process until you have the desired number of balls in your drill. When you have finished setting up your drill, you can push the Start/Stop button to start the drill. The Beta robot will cycle through all the balls in your drill, and then repeat until the Start/Stop button is pushed again.

#### **4.4.4 Saving a Drill**

1. Select the Memory Location where you want to save the drill using the Memory Location Increment/Decrement buttons. Remember that locations 21 through 50 are preconfigured with Drills when purchased.
2. Push and hold the Save button until the LED display becomes blank. This indicates that the drill is saved in the Beta robot's memory.

**Note:** If you save a new drill in positions 21 through 50 (which holds one of the pre-configured drills), you will **overwrite** (and lose) the pre-configured drill in that position!

#### **4.4.5 Modifying an Existing Drill**

1. Push the Start/Stop button to stop the robot from throwing balls.
2. Choose the drill that you would like to modify using the Memory Location Increment/Decrement buttons.
3. Use the Backstep button to select the ball in the drill that you would like to change. (Do not use the Add Ball or Remove Ball buttons for this purpose).
4. Make your desired change using appropriate control(s) (Spin, Speed, Trajectory, etc.)
5. Using the Backstep button select any additional balls that you want to modify and make your changes.
6. Save the drill with your changes by pressing the Save button until the Memory Location becomes blank. This indicates that the Drill has been saved successfully.

#### **4.4.6 Clearing/Removing A Drill from Memory**

If you want to remove a Drill from the Beta robot (clear), perform the following steps:

1. Select the Memory Location for the Drill that you want to remove/clear.
2. Push and hold the Clear button until the Memory Display LED is flashing.

## 4.5 Using the Remote-Control FOB

The Beta robot comes with a small wireless Remote-Control FOB (Photo 4-1) which has a range of 4-5 meters (13-16 feet) giving you the ability to start and stop the robot throwing balls without having to press the Start/Stop button on the Control Panel.

The (+) and (-) keys can be used to increase/decrease the Ball/min setting.

You may wish to keep the remote in your pocket to ease the start/stop of balls during drills.

Photo 4-1



## 4.6 Preparing for Transport and/or Storage

1. Turn off the Beta robot by unplugging the power adapter from the wall power source.
2. Disconnect/unplug the power connector and control panel connector from the side of the Beta Robot Base Assembly. See Photo 4-2.



Photo 4-2



Photo 4-3

3. Disconnect the control panel cable from the control panel. See Photo 4-3.
4. Disconnect the side nets from the table center net supports.
5. Lift the Beta robot from its mounted position on the table, set it on top of the table, and rotate 180 degrees to give you access to the front of the robot.
6. Loosen the throwing height adjustment knob and slowly rotate the throwing head 180 degrees (towards rear of robot) allowing it to drop down so that none of the painted rings are visible.
7. Slightly tighten the throwing height adjustment knob to hold the throwing head in place.
8. Remove all balls from the collection net / ball feed area.



9. Gently raise the two corners of the collection net, to about **halfway** position as shown in Photo 4-4.



Photo 4-4



Photo 4-5



Photo 4-6

10. Unscrew the two thumbscrews on the cable that connects the throwing head to the Robot Base Assembly and unplug the cable. See Photo 4-5.
11. Swivel the base support legs back over the robot base. See Photo 4-6.
12. Fold/tuck as much of the netting, including the side nets, into the center of the partially folded up robot.
13. Gently fold first one side of the net completely down, followed by the other side. Use caution not to force the net, and carefully guide the net supports into position by hand.
14. Place the robot, along with all other pieces into a protective storage/transport box.
15. When transporting, exercise caution to prevent any damage to the robot.

## Section 5: Maintenance and Repair

[Back to Table of Contents](#)

**Caution:** Before performing any maintenance or repairs, unplug your robot from the wall power source.

**Caution:** If you observe any exposed wires on the Power Adapter cord/cabling, disconnect from power immediately and replace. Failure to do so could result in serious harm.

### 5.1 General Cleaning of the Beta Robot

For best performance from the Beta robot and for best longevity, the robot must be kept clean. The surface of the Beta Robot may be cleaned with a moist cloth and a mild, water-based cleanser as necessary. Do not expose the Beta robot to excessive amounts of liquid. Do not submerge any part of the robot in liquid.

**Note:** The Ball Throw wheels have a special coating that prolongs their lifetime. Do not attempt to clean the wheels with any chemical, as chemicals can harm the coating/wheel.

### 5.2 Deflector Assembly / Deflector Strip Cleaning and Replacement

When the Beta robot throws balls, the balls contact the Deflector Assembly left/right surfaces and the Deflector Strip (Photo 5-1). Over time, dust/debris will build up in these areas and if not cleaned, will reduce accuracy and consistency of the thrown balls. During extended use of the Beta robot, the factory installed white Deflector Strip can develop an indentation or even a hole where the balls repeatedly strike it. At that point the Deflector Strip must be serviced. Perform the following procedures to both clean and service/replace the Deflector Strip.

Photo 5-1

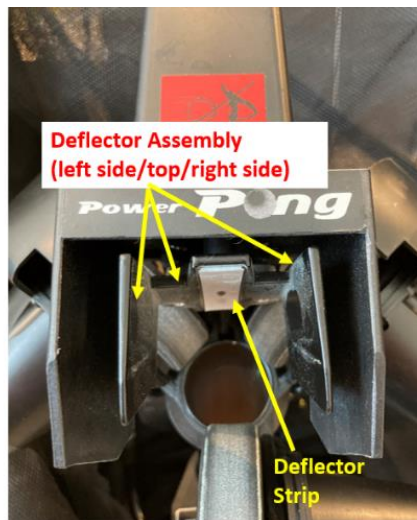

#### 5.2.1 Deflector Assembly/Deflector Strip Cleaning

**Caution:** When cleaning and/or servicing the Deflector Assembly or Deflector Strip, to prevent damaging the Throwing Head assembly, it is critical that the Deflector Assembly is not manually pushed upwards. Always use the robot functionality to move the deflector assembly upwards with the Control Panel Trajectory UP buttons as follows.

1. Turn the Beta robot ON.

2. Push/hold the Trajectory UP button on the Control Panel, to move the Deflector Assembly to the maximum UP position.
3. Turn the Beta robot OFF.
4. Disconnect the Throwing Head cable that plugs into the Robot Base Assembly.
5. Remove the Throwing Head assembly and lay flat on a work surface.
6. While holding the deflector assembly firmly to minimize movement, clean the Deflector Strip and the Deflector Assembly Left/Right surfaces with a soft cloth. If any dust/debris has hardened, it may be necessary to use isopropyl alcohol to clean along with a plastic scraper.

### 5.2.2 Deflector Strip Service/Replacement

When the factory installed Deflector Strip becomes worn to the point where there is an indentation or a hole, you can cover the worn Deflector Strip with one of the replacement Deflector Strips that shipped with your robot. There are two types of Deflector Strips provided as spares. The first is a thin, non-sponge-backed strip - which we will use in this procedure. The second, is a thicker, sponge-backed strip identical to what's installed from the factory. The factory installed sponge-backed Deflector Strip can be covered ONE TIME with the thin non-sponge-backed replacement Deflector Strip. This is a very easy/quick procedure and will provide you with many additional hours of robot usage.

#### Applying the Thin Deflector Strip

To apply the thin replacement Deflector Strip (Photo 5-2) over the sponge-backed Deflector Strip, perform the following:

1. Turn the Beta robot ON.
2. Push/hold the Trajectory UP button on the Control Panel, to move the Deflector Assembly to the maximum UP position.
3. Turn the Beta robot OFF.
4. Disconnect the Throwing Head cable that plugs into the Robot Base Assembly.
5. Remove the Throwing Head Assembly and lay flat on a work surface.
6. While holding the Deflector Assembly firmly to minimize any movement, clean any dust/debris from the installed Deflector Strip
7. Peel the orange-colored paper backing off the thin replacement Deflector Strip (Photo 5-3).
8. Apply the adhesive side of the thin Deflector Strip directly over the factory installed Deflector Strip (Photo 5-4).

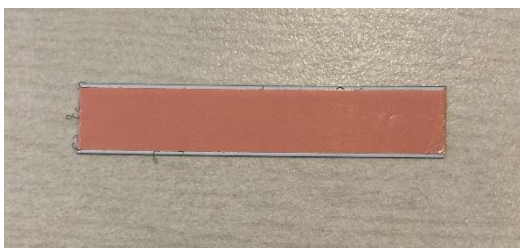

Photo 5-2



Photo 5-3

**Photo 5-4**



### **Replacing the Sponge-Backed Deflector Strip**

When the thin Deflector Strip that was applied over the sponge-backed/factory installed Deflector Strip becomes worn (indentation or hole), you must remove BOTH strips and apply the replacement sponge-backed Deflector Strip. Perform the following:

1. Turn the Beta robot ON.
2. Push/hold the Trajectory UP button on the Control Panel, to move the Deflector Assembly to the maximum UP position.
3. Turn the Beta robot OFF.
4. Disconnect the Throwing Head cable that plugs into the Robot Base Assembly.
5. Remove the Throwing Head assembly and lay flat on a work surface.
6. While holding the deflector assembly firmly to minimize any movement, remove both Deflector Strips from the Deflector Assembly. The original strip will have to be lifted off the Deflector Assembly carefully. If necessary, use a plastic scraper tool to avoid scratching the metal.
7. Peel the orange-colored paper backing off the sponge-backed replacement Deflector Strip.
8. Press firmly/apply as shown in Photo 5-5, as close as possible to where the old strip was removed.

**Photo 5-5**



### 5.3 Throwing Wheel Maintenance

The Beta robot throwing wheels are very durable and typically last for 500-1000 hours. During normal use these wheels will wear. As the wheels wear, the space between the 3 wheels increases, preventing the wheels from properly gripping the ball as it is thrown. An indication that the throwing wheel clearance has increased is when the robot throws balls inconsistently, particularly when throwing at high speed. Use the following procedures to first check the clearance, and then, if necessary, adjust wheel clearance.

When the wheels have worn to the point where they can't be adjusted properly any longer, the wheels must be replaced. All three wheels must be replaced at the same time. Note that the procedure is slightly different for the lower wheel compared to the upper wheels. Perform the procedures as follows.

#### 5.3.1 Checking Wheel Clearance

1. Using a Power Pong supplied table tennis ball, insert into the space between the 3 wheels (Photo 5-6) and move it in and out. The ball should move in and out of this area with slight contact of the 3 throwing wheels. If there is NO contact with the wheels and/or the ball simply falls into the Ball Feed Tube, wheel clearance adjustment is required.

**Note:** New robots will have a tight fit. No adjustment is required in that case.

Photo 5-6



#### 5.3.2 Adjusting Wheel Clearance

Perform the following procedure for wheel adjustment.

1. Use the supplied 4 mm hex wrench, slightly loosen the adjustment screw for each of the 3 motors so that the motors can be moved by hand, but not loose enough so they move without your assistance. See Photos 5-7 through 5-9.



Photo 5-7



Photo 5-8



Photo 5-9

2. Using a table tennis ball, adjust/slide the 3 motors consistently to decrease the gap between the wheels. The ball should pass through the opening while touching the surface of the 3 wheels and requiring a small amount of pressure to pass through the wheels and drop down into the Ball Feed Tube.
3. Tighten the 4 mm adjustment screw for all 3 motors. Retest and re-adjust if necessary.

### 5.3.3 Lower Wheel Removal / Replacement

1. Using the 2 mm hex wrench, loosen but do not remove, the small setscrew that holds the wheel onto the shaft of the motor (Photo 5-10).

Photo 5-10



2. Note how far the wheel was slid onto the motor shaft, and then slide the wheel off the motor shaft.
3. Slide the new replacement wheel onto the motor shaft positioned similarly to the wheel that was previously removed and slightly tighten the setscrew.

4. Manually spin the wheel and ensure that it's not rubbing on any surface. If it is rubbing, loosen the setscrew and slightly move the wheel's position on the shaft. Slightly tighten the setscrew and test again to be sure that the wheel no longer rubs on any surface.
5. When the wheel spins without any rubbing, tighten the screw securely.

### 5.3.4 Upper Wheel Removal / Replacement

The upper wheels are removed and replaced in a slightly different fashion, due to the proximity of the Head Panel and the Oscillation & Trajectory Motor Cover. Follow the procedure below for both upper wheels, however, do one wheel at a time.

1. Remove the throwing head assembly and carefully lay on a work surface.
2. Remove the two Phillips screws that hold the **upper left** motor cover in place and remove motor cover. (Photo 5-11)

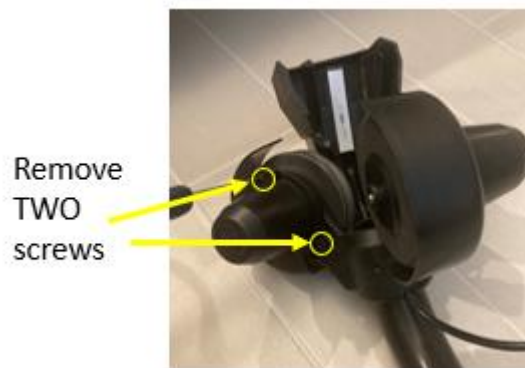

Photo 5-11

3. Remove the Phillips screw and the hex bolt to remove the motor from its mounting location. (Photos 5-12 and 5-13). Note the position of the rubber band securing the motor signal wires. Be careful not to stretch/stress the cable between the motor and the throwing head.



Photo 5-12



Photo 5-13

4. Using the 2 mm hex wrench, loosen but do not remove, the small setscrew that holds the wheel onto the shaft of the motor (Photo 5-10)
5. Note how far the wheel was slid onto the motor shaft, and then slide the wheel off the motor shaft.

6. Slide the new replacement wheel onto the motor shaft positioned similarly to the wheel that was previously removed and slightly tighten the setscrew.
7. Manually spin the wheel and ensure that it's not rubbing on any surface. If it is rubbing, loosen the setscrew and slightly move the wheel's position on the shaft. Slightly tighten the setscrew and test again to be sure that the wheel no longer rubs on any surface.
8. Remount the wheel assembly onto the throwing head assembly.
9. Replace the motor cover on the motor assembly.

#### 5.4 Robot Base Assembly / Lower Ball Feed Path Cleaning

If dirt, debris, hair, etc. has dropped down into the Lower Ball Feed Path, it will have to be opened and cleaned. Perform the following steps.

1. Remove the robot main circuit board. Refer to section 5.6 for this procedure.
2. Set the robot up on the base.
3. Remove the Throwing Head Assembly from the Robot Base Assembly and set securely on the work surface.
4. Separate the Velcro net from the Robot Base Assembly and secure the Velcro out of the way so that you have access to the top of the robot base. (See Photos 5-14 and 5-15)



Photo 5-14



Photo 5-15

5. Remove **16** screws from the top of the robot base as shown in Photos 5-16 through 5-18.

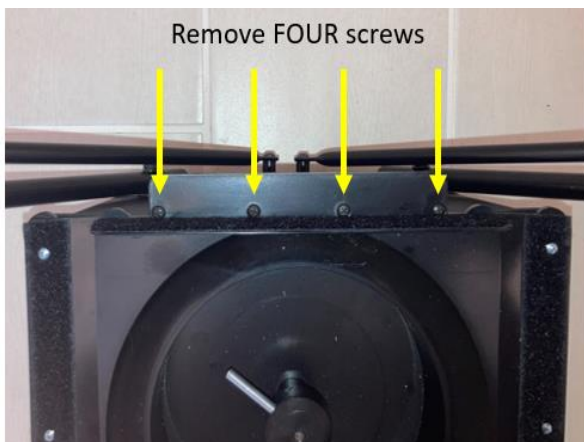

Photo 5-16

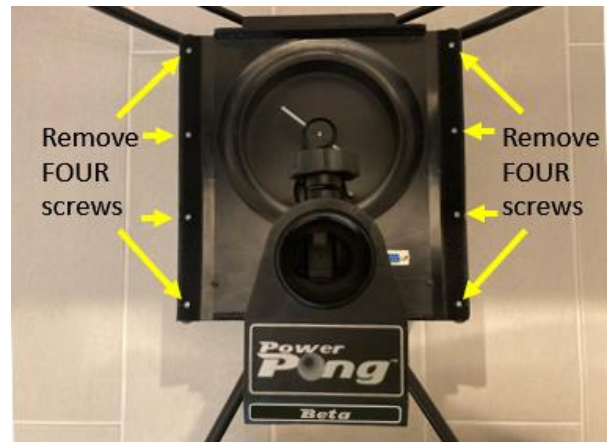
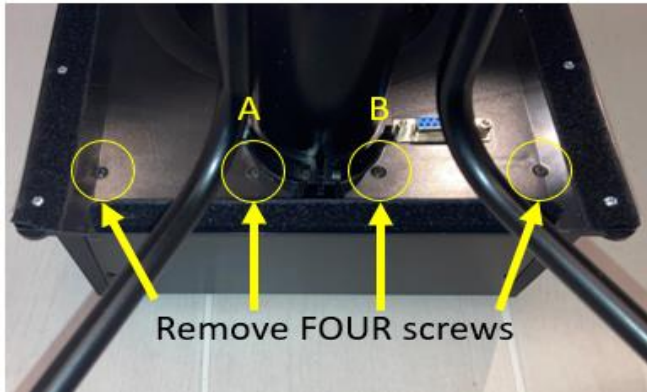

Photo 5-17

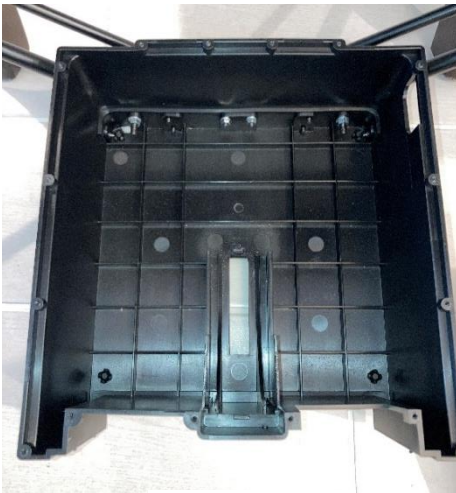



**Photo 5-18**

Note: For the two inner screws (A and B), use a short screwdriver to avoid stripping the screw heads.

6. After removing all 16 screws, gently lift to separate the upper portion of the robot base with the throw arm mounting assembly from the lower robot base. (Photos 5-19 and 5-20)



**Photo 5-19**



**Photo 5-20**

7. Remove any balls in the lower portion of the robot base.
8. Inspect/clean the lower portion of the robot base of any debris, dust, foreign objects, etc. as needed.
9. Examine the feed motor assembly and the gear assembly. Clear/remove any debris, dust, dirt, foreign objects, etc. (See photo 5-20)
10. When all assemblies are cleaned appropriately, re-assemble in reverse order.

**Caution:** Do NOT use a powered screwdriver as you re-insert the screws. The screws are inserted into plastic. To avoid stripping the plastic, only use hand screwdrivers.

## 5.5 Calibration

### 5.5.1 Checking Calibration

The robot comes pre-calibrated from the factory. To test calibration, perform the following:

1. Be sure that the robot legs are adjusted properly for the height of the table. (See Section 2 for details)

2. Turn off the Beta robot (unplug power cord), wait 10 seconds, and turn the robot back on.
3. Set the throwing head to the 2<sup>nd</sup> ring position.
4. Set the Ball/min rotary dial to 25.
5. Push the Start/Stop button or the Start button on the Remote-Control FOB. Balls should be thrown down the center of the table, and land 14-16 inches from the end of the table.

If these tests fail, a calibration may be recommended.

### 5.5.2 Performing Calibration

The goal of calibration is to set the proper placement for basic balls thrown, to the middle of the table and 14-16 inches from the end of the table. In addition, calibration can be used to ensure that there is no spin on the standard basic ball thrown by the Beta.

**IMPORTANT:** Calibration is dependent upon the head working correctly, especially the wheels spinning. Always check for proper head function by powering off and on the robot, and carefully observing the head during the initialization. The Deflector Plate should move left, then right, and then down, followed by all wheels spinning forward for about 2 seconds. If the Deflector Plate does not move accordingly, or all wheels don't spin, then it is unlikely that Calibration can resolve any issues. Further troubleshooting will be required to identify the cause of the issue. (See Section 6: Troubleshooting)

1. Ensure that the throwing head height is set to the 2<sup>nd</sup> ring height.
2. Activate Calibration by holding down both Trajectory Buttons at the same time. The robot will automatically start to throw Balls.
3. Verify that the balls are thrown down the center line of the table. If not, loosen the throwing head lock knob and adjust until the balls are thrown down the center line.
4. If the balls are not thrown far enough, increase the speed by pressing the right Speed button and/or increase the trajectory by pushing the top Trajectory button. If the balls are thrown too far, decrease speed by pushing the left Speed Button and/or decrease the trajectory using the bottom Trajectory button.
5. Remove any sidespin by using one of the Sidespin Buttons.
6. Remove any backspin by using the right Spin Button.
7. Remove any topspin by using the left Spin Button.
8. Push the Start/Stop button to save and exit calibration mode.

## 5.6 Replacing the Battery in Remote-Control FOB

The Remote-Control FOB is powered by two 3V CR2016 button cell batteries. If the Remote-Control FOB stops working, it's likely that the batteries will need to be replaced. Perform the following steps:

1. Open the remote by inserting a coin or flat blade screwdriver in the slot located on the wide end of the Remote and twisting to open. Separate the halves of the remote. See Photo 5-21 and 5-22.

Photo 5-21



Photo 5-22



2. Remove the circuit board containing the batteries from the rubber button pad.
3. Carefully slide the battery holder with the batteries away from the circuit board.
4. Remove the two old batteries from the battery holder and discard the batteries. KEEP THE BLACK BATTERY HOLDER. See Photo 5-23.

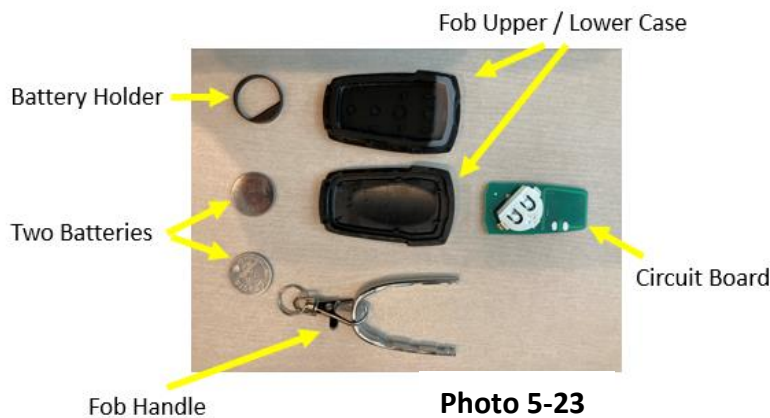

5. Insert two new batteries with the positive side (+) of both batteries facing up into the battery holder as shown in Photo 5-24.
6. Reinsert the battery holder into the circuit board. Orient as shown in Photo 5-25.
7. Reinsert the circuit board into the rubber button pad. (Photo 5-26)
8. Reinsert the rubber button pad with circuit board and batteries into the top housing of the remote control with the battery side up. (Photo 5-27)



Photo 5-24

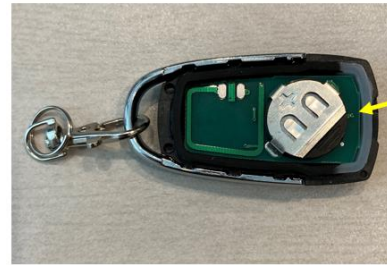

Photo 5-25



Circuit board with new batteries (in holder) inserted into rubber button pad.

Photo 5-26



Rubber button pad with circuit board and batteries inserted into Fob base.

Photo 5-27

9. Position U-shaped handle as shown in Photo 5-27.
10. Place the other half of the plastic fob housing on top and press the top and bottom housings together, starting at the narrow end and working your way to the wide end until the housings snap in place.

### 5.7 Replacing the Main Circuit Board

If the robot does not function and all other possible causes (See Troubleshooting) have been eliminated, the main circuit board in the robot may have to be replaced. Perform the following steps.

1. Access the front panel of the robot. You can identify the front panel by the 4 Phillips screws and the orientation to the robot legs and Ball Feed Tube.
2. Remove the four Phillips screws (Photo 5-28).
3. The circuit board is held in place with one Phillips screw. Remove that screw (Photo 5-29).



Photo 5-28

Remove screw

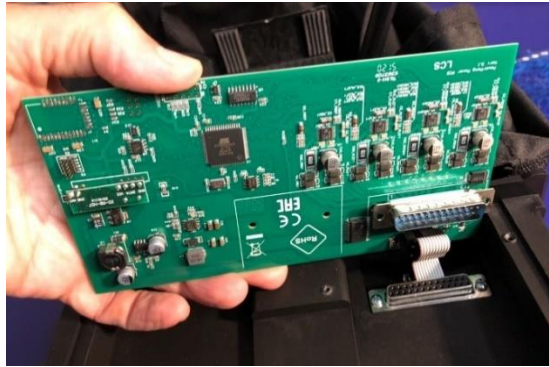

Photo 5-29

**Caution:** To avoid static electricity damage to the circuit board, avoid touching any components or circuit runs on the circuit board. Only touch the outside edge of the circuit board.

4. Gently raise the circuit board from its mounting. This step will disconnect the 25 pin D-Connector shown in Photo 5-30. Grasp the circuit board by the edges only to avoid static damage to components as shown in Photo 5-30.

**Photo 5-30**



5. Unplug the flat ribbon cable from the circuit board as shown in Photo 5-31 and 5-32.



**Photo 5-31**

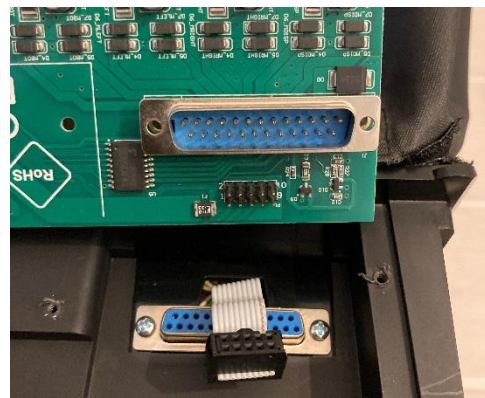

**Photo 5-32**

6. Install the replacement circuit board by first reconnecting the flat cable to the connector on the circuit board. See Photo 5-24.
7. Set the circuit board into place by lining up the 25 pin D-Connector and gently pressing into position.
8. Install the screw (removed previously) that holds the circuit board in place. (See Photo 5-22)
9. Reinstall the panel (removed previously) and secure with 4 previously removed screws (Photo 5-21).

## 5.8 Pairing a New Remote-Control FOB

If you must replace your Remote-Control FOB, it will have to be paired with the Beta robot before it will function. To pair the new Remote-Control FOB with the Beta robot, perform the following procedure.

1. Push and hold BOTH the RND button on the Beta Control Panel, and the Start button on the Remote-Control FOB, and hold for 5 seconds.

## 5.9 Restoring Factory Supplied Drills

If you wish to restore the factory supplied drills, perform the following procedure.

**Note:** Any user-defined drills saved in positions 1-20 will NOT be affected by this procedure.

**Any user-defined drills that you have saved in positions 21-50 WILL BE OVERWRITTEN.**

1. Unplug the power adapter from the AC power source to turn off the robot.
2. While pressing and holding the Save button on the Beta Control Panel, plug the power adapter into the AC power source.
3. After 5 seconds, release the Save button. The factory supplied Drills are now restored.

## 5.10 Typical Replacement Parts

Visit [www.powerpong.org](http://www.powerpong.org) for an online listing of parts that can be ordered. Contact Power Pong support to order and/or for any parts that are not listed. Below are common replacement parts.

1. Power Adapter
2. Throwing Disks/Wheels
3. White Deflector strips (both Sponge-backed and non-Sponge-backed)
4. Black replacement rubber bands for attaching collection net sides to table net supports.
5. Throwing Height Adjustment Knob

## Section 6: Troubleshooting

[Back to Table Of Contents](#)

### 6.1 Ball Jams

Ball jams are infrequent, and your robot can detect and react to problems in the ball channel. When the system detects a jam, it will attempt to automatically clear it by turning the Ball Feed Motor forward and backward.

Ball jams can be caused by several issues shown in the following list. Verify that none of the issues exist with your Beta robot.

- dirt/debris/foreign objects in the ball feed path including on white deflector strip
- dirty/unwashed and/or multiple ball sizes being used simultaneously
- damaged ball or balls
- throwing wheels out of adjustment
- incorrect throwing head height (pay attention to rings)
- damaged Ball Feed Tube (if yes, contact Power Pong support)

If you do experience a ball jam, perform the following steps to clear it.

1. Unplug the Beta robot from the power source.
2. Check that a ball is not stuck among the 3 wheels (This can happen after adjusting the head height down). If so, simply remove those balls by hand and resume normal operations.
3. Remove all balls from the Beta robot.
4. Loosen the Throwing Height Adjustment Knob that secures the Ball Feed Tube and carefully remove the throwing head assembly from the robot, keeping it connected. Lay on work surface.
5. Lay the robot base on its side and push a pencil up into the access hole to free any stuck balls. Balls should move freely.
6. Plug the Beta robot back into the power source which will restart robot.
7. Remove all the balls from the collection area so that you can see the springs moving
8. Verify that the spring moves in one direction only. (Without any balls in the machine, the ball stirring mechanism should rotate approximately 11-12 times before it stops)
9. If spring are moving in both directions, additional troubleshooting is required. (See Troubleshooting)
10. Using a pencil, then check that a ball moves through the tube without obstruction. If springs move in both directions, call support.
11. If the spring moves in one direction only, the ball jam has been cleared. You can reassemble and resume normal operation.
12. If it still moves in both directions, contact support for additional help.
13. Push one ball through the wheels and ensure that ball goes all the way through.

## 6.2 General Troubleshooting

PROBLEMS	POSSIBLE SOLUTIONS
Ball Throwing Head or Support Legs point towards back of robot.	Loosen the Throwing Height Adjustment Knob on the rear of the Ball Feed Tube Locking Assembly, then rotate head 180° so head points away from net. Grasp Support Legs and rotate them away from net (See Section 2).
Control Panel LEDs light up, but no balls are thrown.	Be sure that the Ball/Min knob is set to a level greater than zero. Press the Start/Stop button or Start/Stop on Remote-Control FOB to start ball delivery.
Balls thrown to wrong location.	Are there rubber bands around the Deflector? If yes, remove the bands so Deflector Plate can move freely. Those parts are used only during transport. Verify deflector plates are clean and there is no build-up (side or top). (Section 5) Disconnect AC power source. Disconnect/reconnect both ends of the Control Panel cable. Disconnect/reconnect the Throwing head cable. Check to be sure that no pins are bent/damaged. 15 pins must be present. Reconnect AC power.
Balls thrown at irregular depths.	Check wheel clearance. (Section 5) Wheels worn. Replace all 3 wheels. (Section 5) Clean White Strip on Deflector Plate with isopropyl alcohol. Replace if worn. (Section 5)
Double throws or missed throws.	Head height improperly adjusted. Must be locked in place with ring just above lock point. (Section 2)
Random function (RND) on the control panel cannot be activated. LED won't turn on.	To use the Random function in a drill, there must be at least two Balls defined in the drill. If only one Ball LED is lit, add a second Ball.
Balls get stuck between the ball throw discs. Yellow lights may be flashing on the control panel.	Turn off power and remove the ball(s). If balls continuously become stuck, there may be a bad Ball Throw Motor. .

**Note:** If you are not able to solve a problem with the help of this Troubleshooting guide, please contact Power Pong support for additional assistance. Refer to Section 1-5.



## Technical Data

Electrical Specifications: 100-230V, 50-60Hz AC, approximately 60W Can be operated in a temperature range of 0–40°C (32–104°F).

Weight: 6 kg with net (13.2 lbs.), Overall dimensions (folded, with net): Height 0.75m, Width 0.28m, Depth 0.25m (2.5 x 0.9 x 0.8 feet).

An examination was done for the Power Supply:

Conformity with Low Voltage Directive 73/23/EEC, as last amended by EEC Directive 93/68/EEC—Registration #: AN 50091861 0001, Report #: 17004848 001. Also Test Reports # NTEK2010NT1115351E and NTEK-2010NT1115353SS.

The Power Pong BETA table tennis robot is permitted to bear the CE trademark.

Manufacturer: LCS.kft

## Warranty Information

### FULL 3 YEAR MANUFACTURER'S WARRANTY

Manufacturer warrants to the original retail purchaser this product to be free from defects in material and workmanship for a period of 3 years from date of purchase.

Should the Power Pong Beta robot become defective due to material or workmanship during the warranty period, contact Power Pong support. You will be provided with return authorization and shipping instructions, or you will be sent a replacement part and instructions for replacement. If you must return the product, please pack it securely.

This warranty is not transferable and does not cover normal wear and tear, or damage caused by improper handling, installation, or use. This warranty is void if the product is in any way abused, damaged, or modified from its original state.

This warranty gives you specific legal rights, and you may have other rights that may vary from state to state, or country to country.